

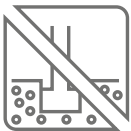

TRANSFORMER SYSTEM FOR LIFE IN EXTREME CONDITIONS

**mtb** | mobile  
transforming  
bed

"MTB" trademark presents a reliable, compact, and comfortable 3-in-1 transformer system: bed + sofa + stretcher. "MTB" system is effective for life in any extreme conditions. It is perfect for solution of military tasks and deployment of field hospitals and camps.



For any weather / location / ground



Quick assembly and disassembly: by hand, no tools required



Box / Bag: easy storage and logistics



Compatibility with tents / pavilions / domical structures



Quick assembly: 1 person = 1 bed = 3 min.



Weight capacity: up to 450 kg / 1 bed



Varieties: 1-3 tiers / 1 bed

**Transformer system for life in extreme conditions**

“MTB” system design ensures quick transformation of your bed into the stretcher without any additional tools required. This is done easily by removing the supports of the upper bed tier and twisting in of stretcher handles into disk holes.



Quick transformation:  
by hand, no tools required



Lightweight design  
(weight: 10.5 kg / stretcher)



Prompt evacuation of  
injured persons and cargoes



Withstands the weight  
of up to 300 kg / stretcher

**All beds are transformed into stretchers.  
There are no analogues in the world!**

All "MTB" TM solutions, except for "MTB ARMY Hospital", can be assembled quickly by hands into 1-, 2-, or 3- tier beds, a sofa, and a stretcher. The system has high strength and is reliable and compact. It can accommodate up to 3 people on 1.5 m<sup>2</sup>. Two options are available for easy storage and transportation of unassembled "MTB" systems – a box and a bag.



**Night:**  
bed for the night  
time rest;

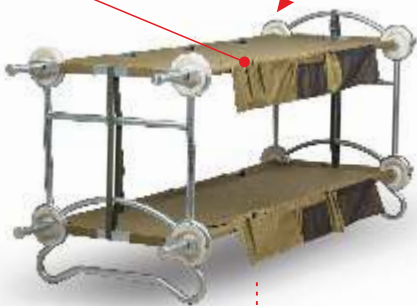

**Stretcher:**  
for evacuation  
of injured  
persons or cargoes;



**1-tier bed:**  
for accommodation  
of 1 person;



**Day: sofa**  
bed is easily  
transformed into a sofa;



**2-tier bed:**  
for accommodation  
of 2 persons;



**3-tier bed:**  
for accommodation  
of 3 persons;

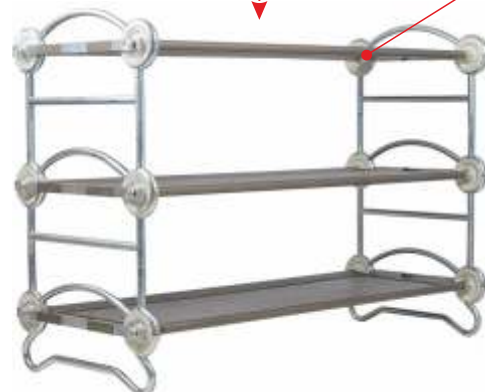

**3-in-1 Transformer system:  
bed + sofa + stretcher**



The frame is tighter and more rigid due to fabric tension along the entire perimeter of the carcass

**Orthopedic bed:**  
the spine gets correct positioning owing to the rigidity of the frame and the uniform tension of the fabric

**Corrosion resistance:**  
galvanized coating or powder coating of all metallic parts

**Reliable and safe design:**  
withstands the weight of up to 450 kg

**2nd tier load:**  
up to 150 kg

**Height adjustment:**  
removable extender (150 mm) to increase the distance between tiers

**1st tier load:**  
up to 300 kg

**Breathable fabric:**  
contributes to body thermoregulation

**Replaceable legs:**  
the bed may be set on both hard and soft grounds

**Organizer for personal belongings:**  
installed on each tier, secured by Velcro

**Wear-resistant fabric:**  
state-of-the-art high-strength Cordura material (density: 1 000 den)

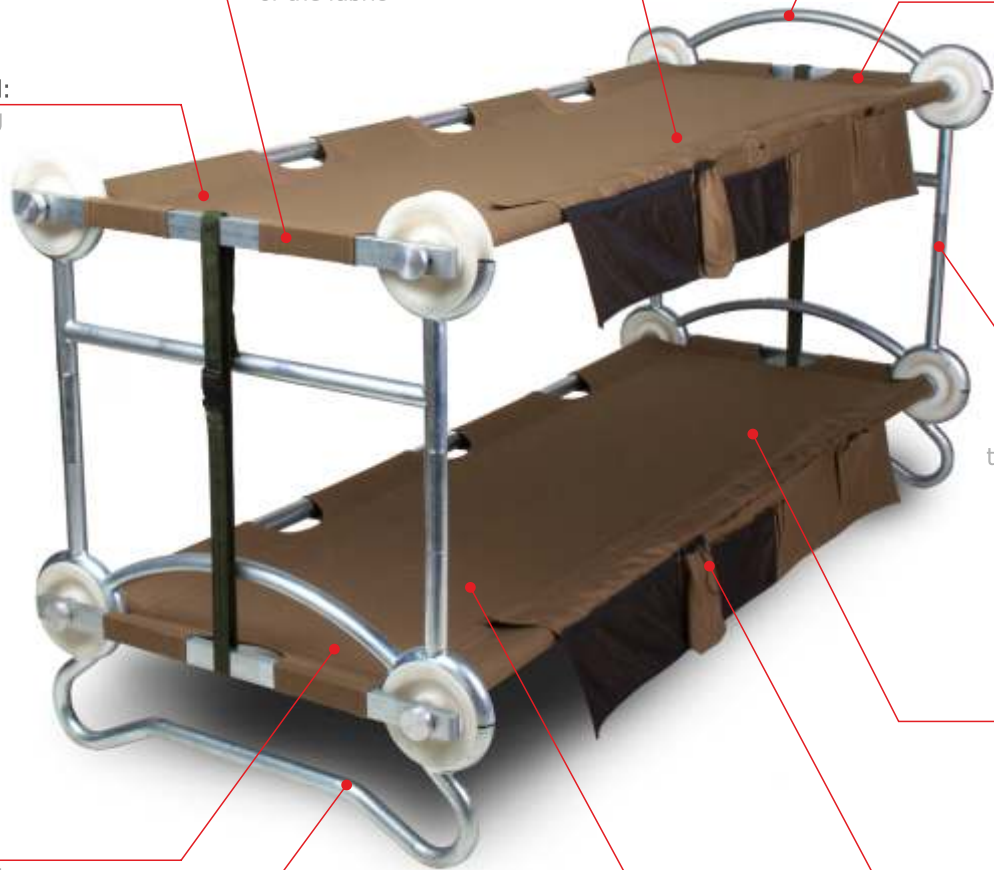

Orthopedic effect



Corrosion resistance



Breathable fabric



Fabric tension along the entire perimeter

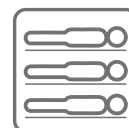

Accommodation of up to 3 persons on 1.5 m<sup>2</sup>

**3 year warranty for all "MTB" systems**



Assembly speed:  
up to 3 min. / bed



Easy assembly and disassembly:  
by hands, no tools required



Quick and easy  
transformation into a stretcher



Quick and easy transformation  
into a sofa

**Quick assembly and disassembly:  
1 person = 1 bed = 3 minutes**

**REDUCTION OF TRANSPORTATION AND STORAGE COSTS**

All "MTB" models are dismantled and stored in compact boxes, enabling the opportunity to load to a transport vehicle twice as many "MTB" systems as conventional beds.

Compact size of the boxes cuts down the bed storage space by three times.

**«MTB» SYSTEM**

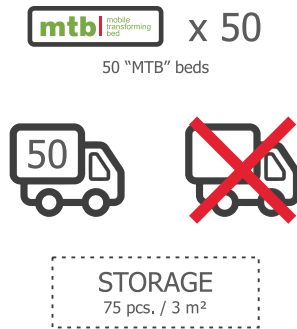

**STANDARD BED**

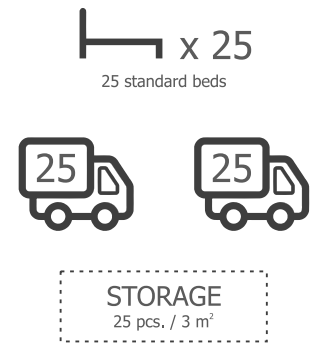

**REDUCTION OF ACCOMMODATION COSTS**

All "MTB" systems (except for "MTB ARMY Hospital" model) provide a possibility of installation of the third bed tier, allowing the accommodation of up to 3 persons on 1.5 m<sup>2</sup> in any extreme conditions.

"MTB" systems ensure the accommodation of up to 6 persons at one tent, whereas conventional beds can accommodate only 2 persons at one tent.

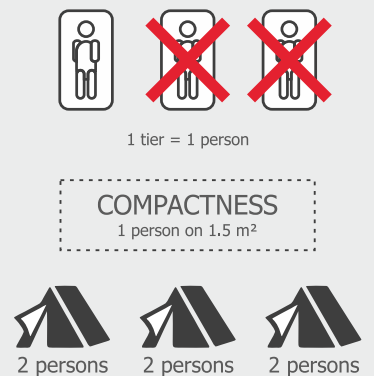
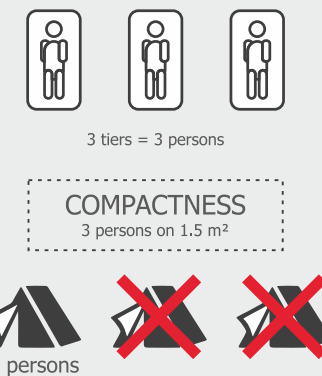

**REDUCTION OF BED AND FURNITURE PROCUREMENT COSTS**

All "MTB" systems have built-in storage system capacities: organizers, bags, and boxes.

An "MTB" model may replace two conventional army beds and a bedside table. Such unit saves furniture procurement funds and does not require too much space for its placement.

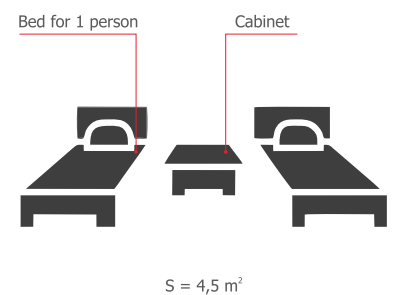
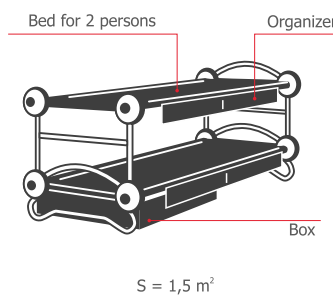

**REDUCTION OF BED RENOVATION AND REPAIR COSTS**

All metallic parts of "MTB" systems are resistant to corrosion; all types of fabric are notable for their enhanced wear resistance and are looked after easily. All models can be dismantled. Subject to any damage to, or loss of, any "MTB" element, it may be purchased as a separate element and replaced promptly.

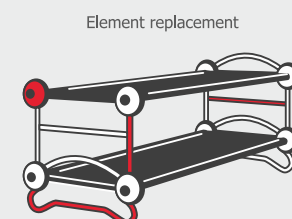









**mtb** | mobile transforming bed



«MTB ARMY Full Set»	«MTB ARMY Standard»	«MTB ARMY Ground»	«MTB ARMY Comfort Ground»	«MTB ARMY Hospital»
				
Width = <b>700 mm</b> 2 tiers	Width = <b>700 mm</b> 2 tiers	Width = <b>700 mm</b> 2 tiers	Width = <b>800 mm</b> 2 tiers	Width = <b>700 mm</b> 1 tiers
Maximum set	Budget bed	Budget bed	Enhanced budget bed	Bed for field hospitals
Arc-shaped legs: for any surfaces	Straight legs for hard surfaces	Arc-shaped legs: for soft and hard surfaces	Arc-shaped legs: for soft and hard surfaces	Straight legs for hard surfaces
Side-slotted Belt-type fabric	Standard - type fabric	Standard -type fabric	Side-slotted Belt-type fabric	Center-slotted Hospital-type fabric
2 bags + 1 box	1 box	1 box	1 box	1 box
Organizer for personal belongings			Wider sleeping berth (+100 mm) Larger distance between the tiers (+150 mm)	Larger distance between the floor and the sleeping berth (+150 mm)

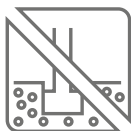

For any weather / location / ground



Quick assembly and disassembly: by hand, no tools required



Box / Bag: easy storage and logistics



Compatibility with tents / pavilions / domical structures



Quick assembly: 1 person = 1 bed = 3 min.



Weight capacity: up to 450 kg / 1 bed



Varieties: 1-3 tiers / 1 bed

**The best solution for army missions!**

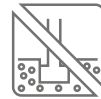
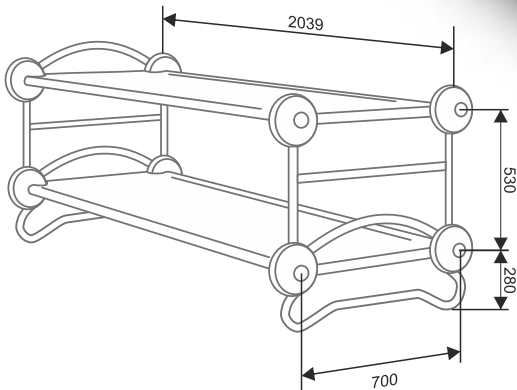

Arc-shaped legs: for soft surfaces



Fabric: Belt, 1000 den, high-strength



Side slots for fastening by "Fastex" belts



Belts with "Fastex" latch fasteners: for fixation during stretcher transport

"MTB ARMY Full Set" model is the most complete one of all "MTB" solutions offered. The bed has been designed for placement on both hard and soft surfaces.

**Features:** High-strength Belt-type fabric with side slots for fastening with belts; blocking belts with "Fastex" latch fasteners; organizers to keep personal belongings; 2 bags for convenient and easy disassembled bed storage and transportation; arc-shaped legs for soft and hard surfaces.

Width of the sleeping berth, mm	700
Fabric type	Belt (cordura), 1000 den
Leg type	Arc-shaped
Possibility to insert extender	Yes
Organizer / 1 set	2
Storage and transportation in a disassembled state / 1 set	Box (1 pc)    Bag (2 pcs)
	Box: L x W x H (mm) = 1018 x 718 x 198 Box gross weight = 57.8 kg
Dimensions and weight in a disassembled state / 1 set	Bag: L x W x H (mm) 2 bag gross weight = 39 kg

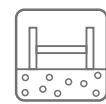
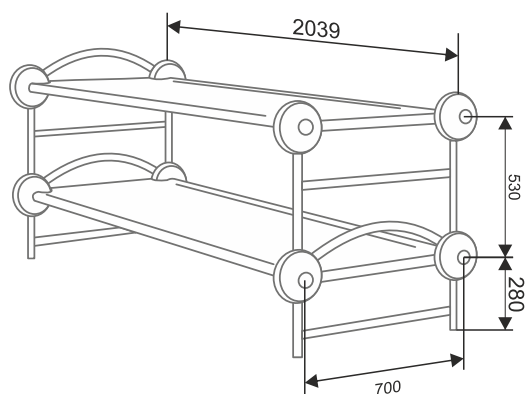
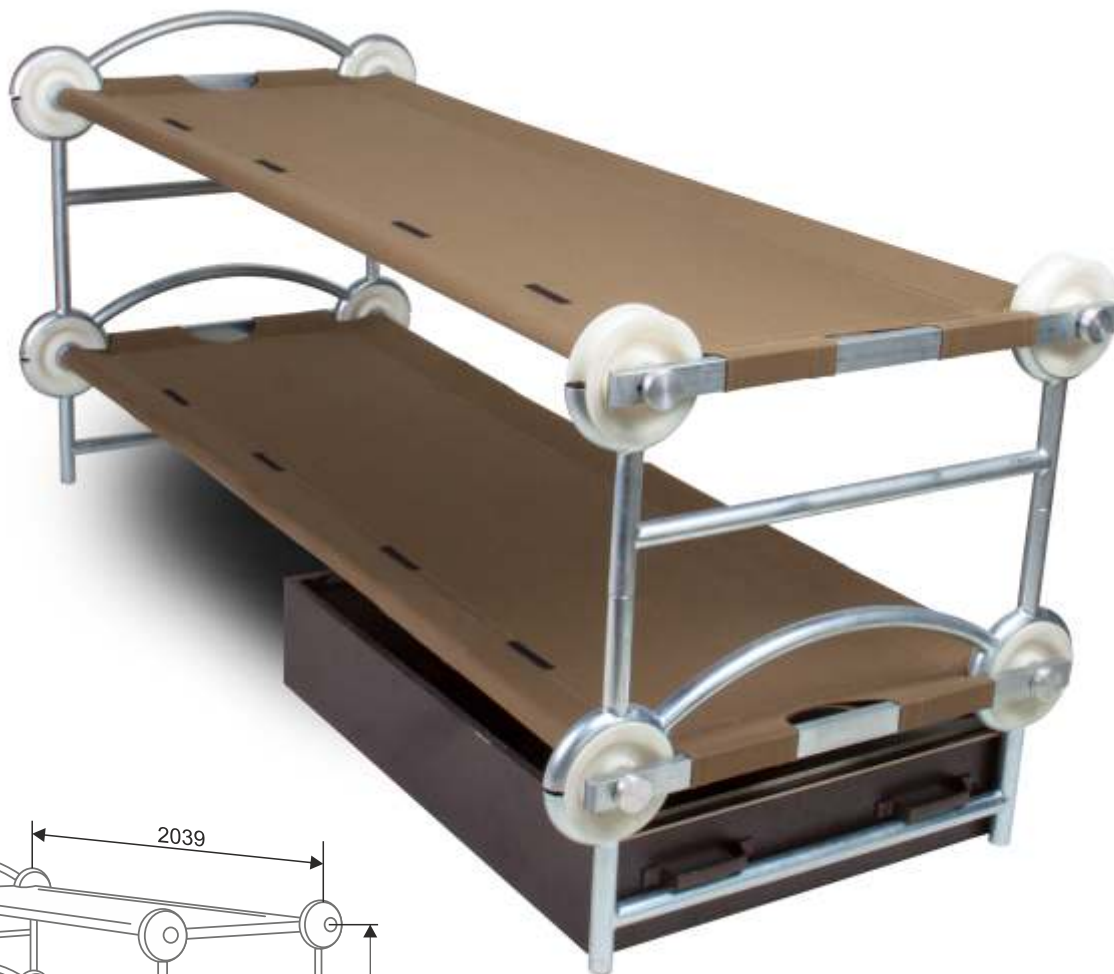

Straight legs: for hard surfaces



Fabric: Standard, 600 den



Tight fabric tension along the entire perimeter

“MTB ARMY Standard” model is a budget solution for accommodation of people in extreme situations. The bed has been designed for hard surfaces only.

**Features:** wear-resistant Standard-type fabric with no side slots; tight fabric tension along the entire bed perimeter; straight legs for hard surfaces.

Width of the sleeping berth, mm	700
Fabric type	Standard (cordura), 600 den
Leg type	Straight
Possibility to insert extender	Yes
Organizer / 1 set	-
Storage and transportation in a disassembled state / 1 set	Box (1 pc)
Dimensions and weight in a disassembled state / 1 set	Box: L x W x H (mm) = 1018 x 718 x 198 Box gross weight = 51,8 kg



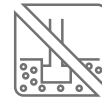
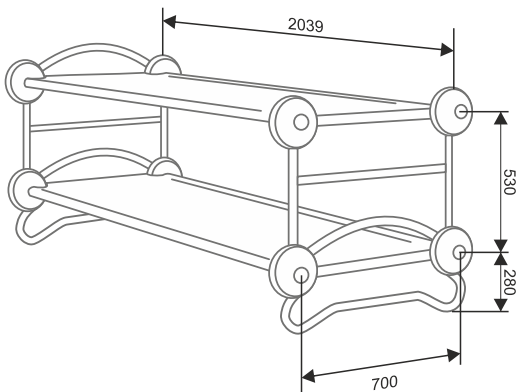
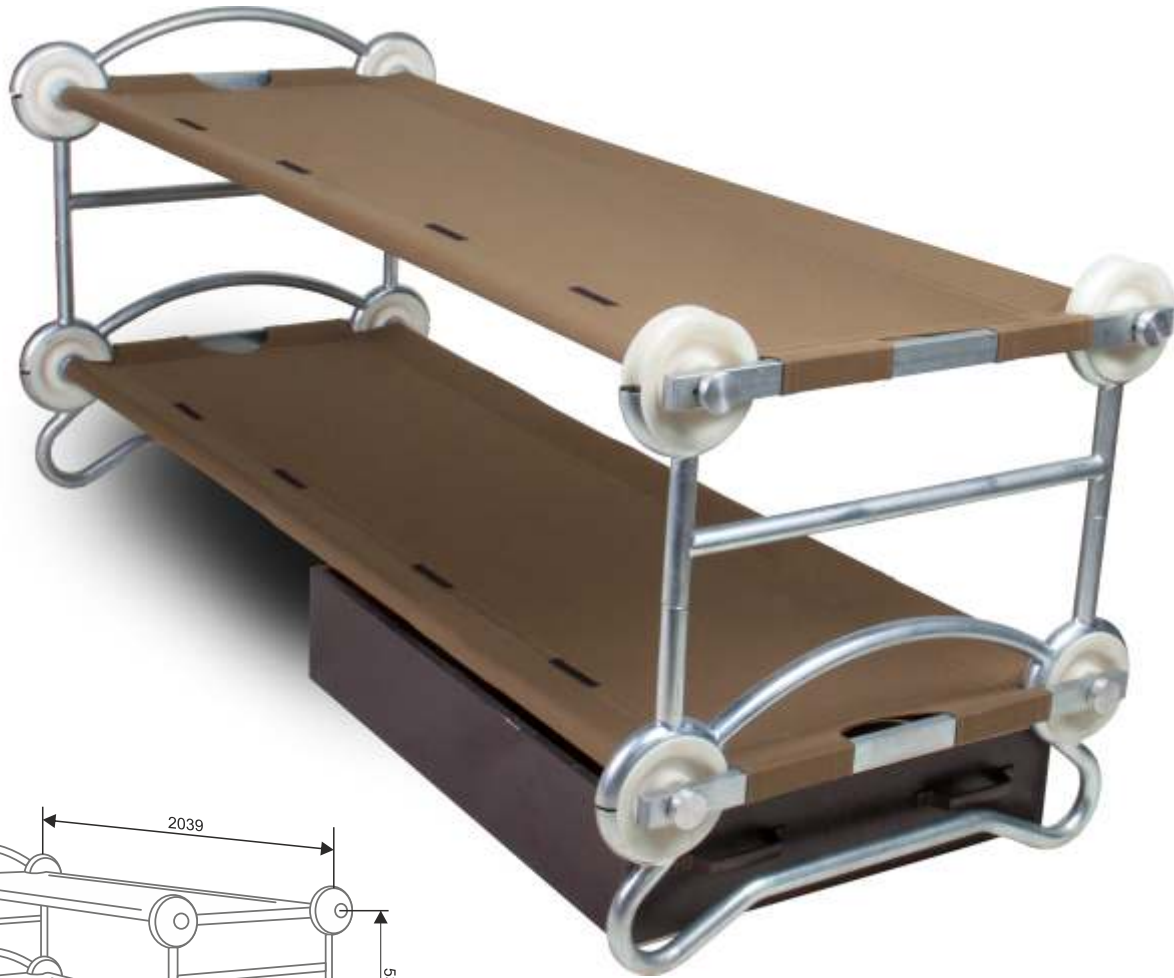

Arc-shaped legs for soft surfaces



Fabric: Standard, 600 den



Tight fabric tension along the entire perimeter

“MTB ARMY Ground” model is a variation of the “MTB ARMY Standard” set, but with arc-shaped legs for bed placement on soft surfaces.

**Features:** wear-resistant Standard-type fabric with no side slots; tight fabric tension along the entire bed perimeter; arc-shaped legs for both soft and hard surfaces.

Width of the sleeping berth, mm	700
Fabric type	Standard (condura), 600 den
Leg type	Arc-shaped
Possibility to insert extender	Yes
Organizer / 1 set	-
Storage and transportation in a disassembled state / 1 set	Box (1 pc)
Dimensions and weight in a disassembled state / 1 set	Box: L x W x H (mm) = 1018 x 718 x 198 Box gross weight = 52.3 kg

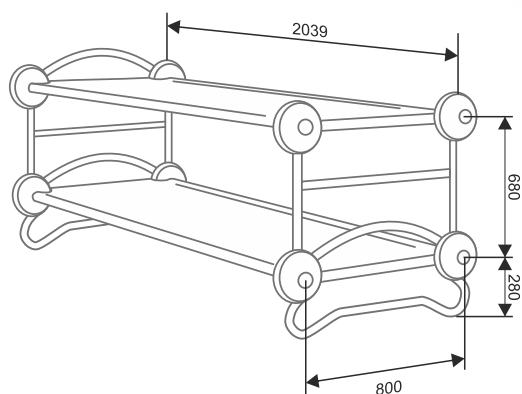
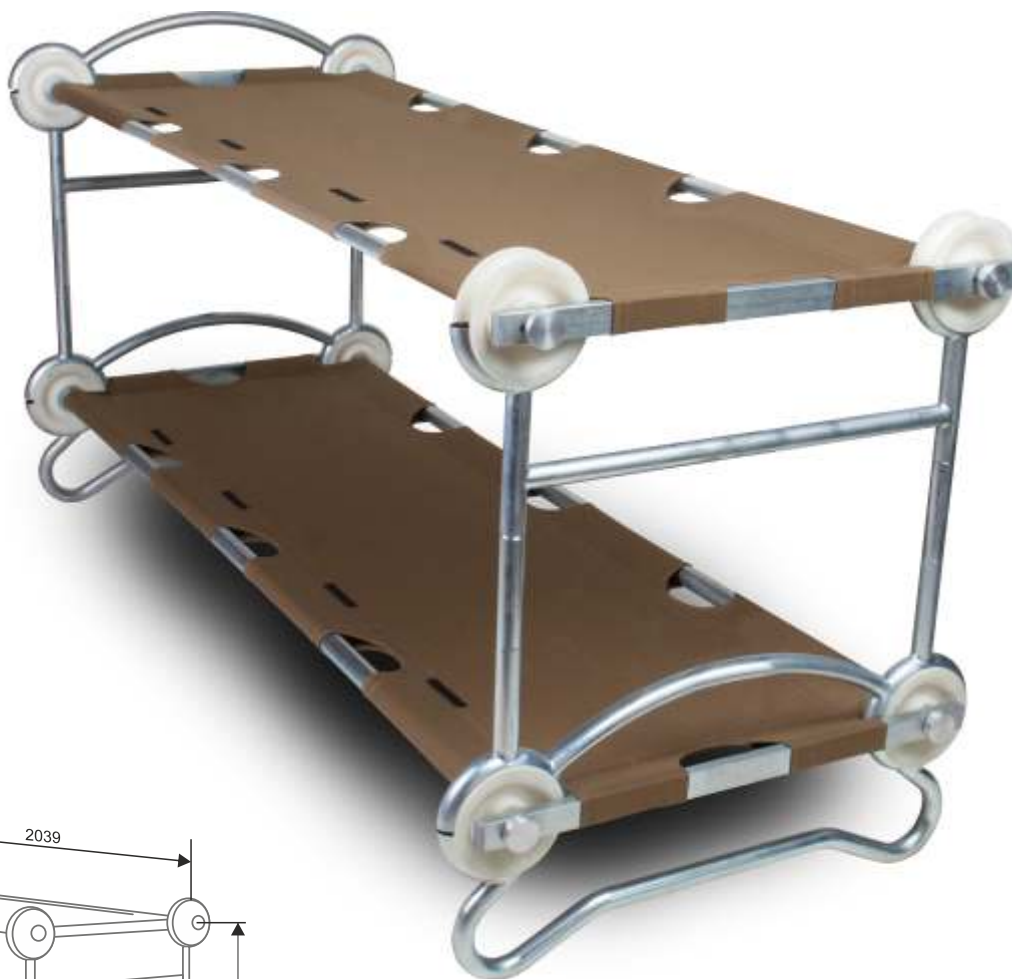

Arc-shaped legs for soft surfaces



Fabric: Belt, 1000 den, high-strength



Tight fabric tension along the entire perimeter



Bed width +100 mm for more comfortable sleeping



Distance between tiers +150 mm for more comfortable seating

“MTB COMFORT Ground” model is a variation of the “MTB ARMY Ground” set, but with increased dimensions of the sleeping berth and distance between the tiers, thereby ensuring more comfortable rest. The bed has been designed for soft surfaces.

**Features:** width of the sleeping berth is increased by 100 mm, reaching 800 mm instead of the standard 700 mm width; distance between the tiers is increased by 150 mm, reaching 680 mm instead of the standard 530 mm distance; high-strength Belt-type fabric with side slots for fastening with belts; arc-shaped legs for soft and hard surfaces.

Width of the sleeping berth, mm	800
Fabric type	Belt (cordura), 1000 den
Leg type	Arc-shaped
Distance between 1st and 2nd tier, mm	680
Organizer / 1 set	-
Storage and transportation in a disassembled state / 1 set	Box (1 pc)
Dimensions and weight in a disassembled state / 1 set	Box: L x W x H (mm) = 1018 x 718 x 198 Box gross weight = 54,3 kg

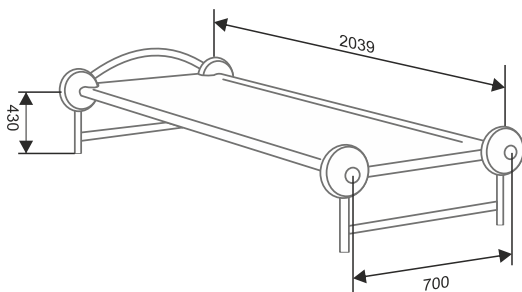

Straight legs for hard surfaces



Center-slotted for sanitary treatment



Resistance to wound-management solutions



Compliance with the highest hygiene requirements



Fabric: Standard, 600 den

“MTB ARMY Hospital” model has been designed for utilization at field hospitals with hard floor surfaces for only 1 patient. It complies with the most stringent requirements on the hygiene, mobility, and sleep efficiency.

**Features:** Increased distance between the floor and the sleeping berth (+ 150 mm). Hospital-type fabric meets the most exacting hygiene requirements and is resistant to the frequent use of wound-management solutions. A hole in the sleeping berth center takes into consideration the need for quick and frequent sanitary treatment of bedridden patients (for instance, patients with cholera or Ebola fever).

Width of the sleeping berth, mm	700
Fabric type	Hospital (vinyl), 600 den
Leg type	Straight
Number of bed tiers / 1 set	1
Organizer / 1 set	-
Storage and transportation in a disassembled state / 1 set	Box (1 pc)
Dimensions and weight in a disassembled state / 1 set	Box: L x W x H (mm) = 1018 x 718 x 198 Box gross weight = 12 kg



**BOX**



Material: plywood  
 Color: brown  
 Dimensions: L x W x H (mm) = 1018 x 718 x 198  
 Set: 2-tier bed  
**Feature:** can be used as a footrest on wet grounds

**BAG**



Material: Cordura (600 den)  
 Color: green, mustard-yellow, orange  
 Dimensions: L x W x H (mm) = 930 x 170 x 400  
 Set: 1 bag = 1 tier bed / 2 bags = 2 tier bed  
**Feature:** every element in the bag is fixed

**ORGANIZER**



Material: Cordura (600 den)  
 Color: green, mustard-yellow, orange  
 Dimensions: L x W x H (mm) = 1600 x 290  
**Feature:** easy fastening / unfastening by Velcro

**BLOCKING BELT**



Material: nylon  
 Color: green, black  
 Dimensions: L x W (mm) = 2000 x 40  
 Latch fastener type: "Fastex"  
**Feature:** reliable fixation of any stretcher-carried cargoes

**BED FRAME**



Material: steel  
 Covering: galvanized / powder coating  
**Feature:** strength margin for the 1st tier – 300 kg; for the entire design – up to 450 kg of the total load

**LEGS**



Material: steel  
 Covering: galvanized / powder coating  
**Feature:** removable legs may be replaced depending on the surface type

**EXTENDER**



Material: steel  
 Coating: galvanizing / powder coating  
 Length: 200 mm  
**Feature:** increases distance between bed tiers by 150 mm

**HANDLES FOR STRETCHERS**



Material: steel  
 Coating: galvanizing / powder coating  
 Length: 270 mm

**STANDARD-type fabric:**

Material: Cordura (600 den)

Composition: nylon fabric with a special thread structure, hydrophobic treatment, and the polyurethane coverage

Color: green, mustard-yellow, orange

Dimensions: L x W (mm) = 2000 x 700, 2000 x 800

Recommended for systems: "MTB ARMY Standard", "MTB ARMY Ground"

**Feature:** tight tension along the entire bed perimeter; no side slots

**BELT-type fabric:**

Material: Cordura (1000 den)

Composition: nylon fabric with a special thread structure, hydrophobic treatment, and the polyurethane coverage

Color: green, mustard-yellow, orange

Dimensions: L x W (mm) = 2000 x 700, 2000 x 800

Recommended for systems: "MTB ARMY Full Set", "MTB COMFORT Ground"

**Feature:** 3 slots on each side for fixation with "Fastex" belts during the stretcher transport

**HOSPITAL-type fabric:**

Material: vinyl (600 den)























Composition: polyester or polyamide fiber, covered with a thin layer plasticized polyvinylchloride

Color: mustard-yellow, orange, blue

Dimensions: L x W (mm) = 2000 x 700

Recommended for: "MTB ARMY Hospital"

**Feature:** a hole in the sleeping berth center takes into consideration the need for quick and frequent sanitary treatment of bedridden patients (for instance, patients with cholera or Ebola fever)

№	Item	Element image	Element	MTB ARMY Full Set (700)	MTB ARMY Standart (700)	MTB ARMY Ground (700)	MTB ARMY Comfort Ground (800)	MTB ARMY Hospital (700)
1	HP-700		Transverse shaped tube	4	4	4	-	2
2	HP-800		Transverse shaped tube	-	-	-	4	-
3	HR-800		Extreme longitudinal tube with a ring	8	8	8	8	4
4	HC-700		Central longitudinal tube	4	4	4	4	2
5	DS		Disk	8	8	8	8	4
6	HS		Stretcher handles with locks	8	8	8	8	4
7	VE-150		Extender (150 mm)	option	option	option	4	-
8	VB-700		Cushion restrictor	1	1	1	-	1
9	VB-800		Cushion restrictor	-	-	-	1	-
10	VCA-700		Middle arc-shaped support	2	2	2	-	-
11	VCA-800		Middle arc-shaped support	-	-	-	2	-
12	VDA-700		Bottom arc-shaped support	2	-	2	-	-
13	VDA-800		Bottom arc-shaped support	-	-	-	2	-
14	VH-700		Bottom H-shaped support	2	4	2	-	2
15	VH-800		Bottom H-shaped support	-	-	-	2	-
16	TB-700		Side-slotted Belt-type fabric	2	option	-	-	option
17	TB-800		Side-slotted Belt-type fabric	-	-	-	2	-
18	TS-700		Standard fabric	-	2	2	-	-
19	TH-700		Center-slotted Hospital-type fabric	-	-	-	-	1
20	OR		Organizer	2	option	option	option	option
21	SF		Blocking belt with a "Fastex" latch fastener	4	2	2	2	-
22	BG		Bag	2	option	option	option	-
23	BX		Box	1	1	1	1	1





MTB TECHNOLOGY LP  
SUMMIT HOUSE 4-5 MITCHELL STREET  
EDINBURGH SCOTLAND EH6 7BD  
Phone: +44 20 8133 4388 (UK)  
sales@mtb.army  
www.mtb.army

Designed specifically for the United Nations and the International Committee of the Red Cross

